

DO NOT SCALE FROM THIS DRAWING. USE FIGURED DIMENSIONS IN ALL CASES.  
 VERIFY DIMENSIONS ON SITE AND REPORT ANY DISCREPANCIES TO THE ARCHITECTS IMMEDIATELY.  
 THIS DRAWING IS TO BE READ IN CONJUNCTION WITH THE ARCHITECTS SPECIFICATION.  
 THIS DRAWING IS COPYRIGHT AND MAY ONLY BE REPRODUCED WITH THE ARCHITECTS PERMISSION.

NOTES

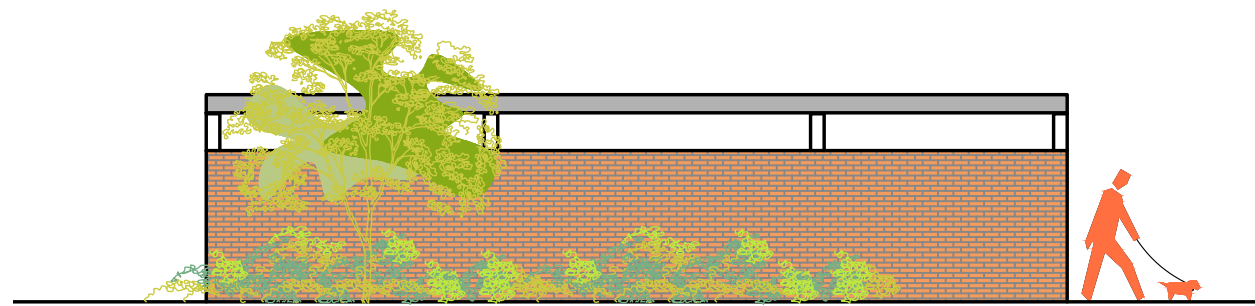

FRONT ( SOUTH) ELEVATION

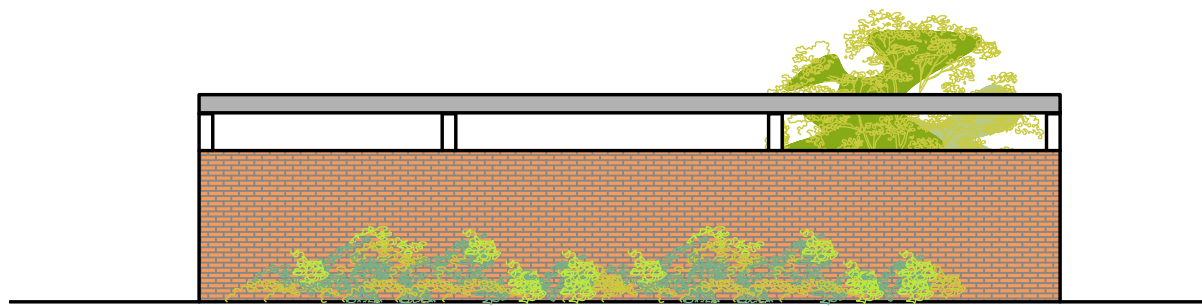

REAR ( NORTH) ELEVATION

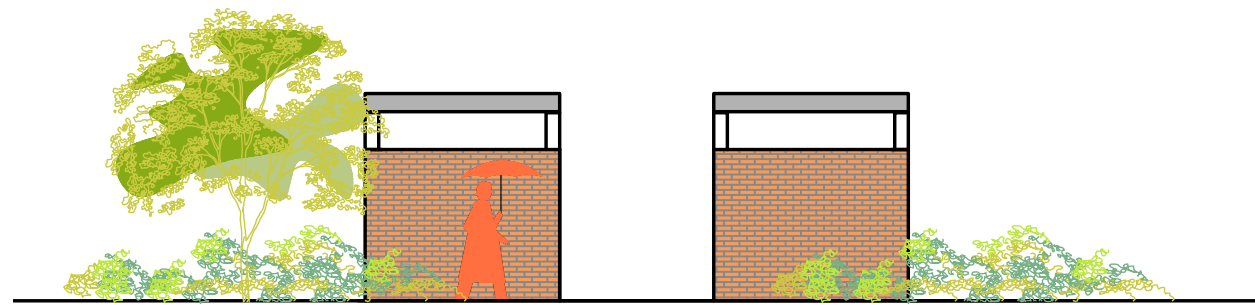

SIDE ( WEST) ELEVATION

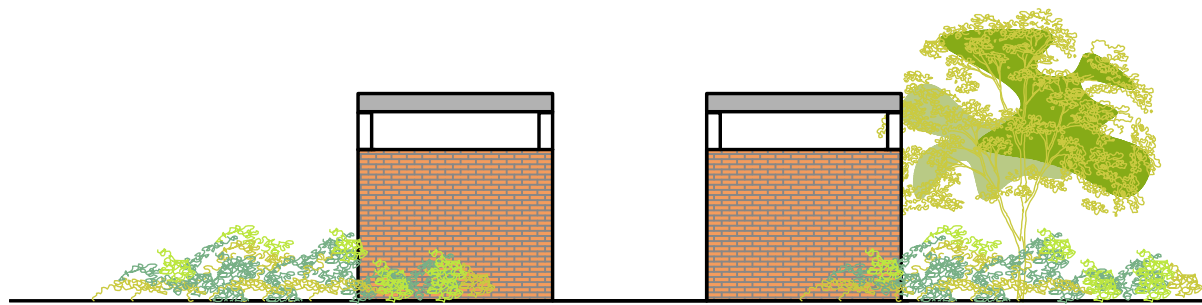

SIDE ( EAST) ELEVATION

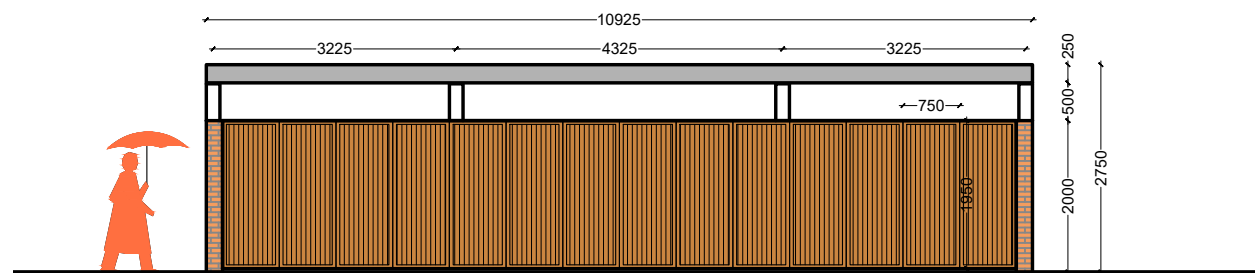

SECTIONAL ELEVATION A-A

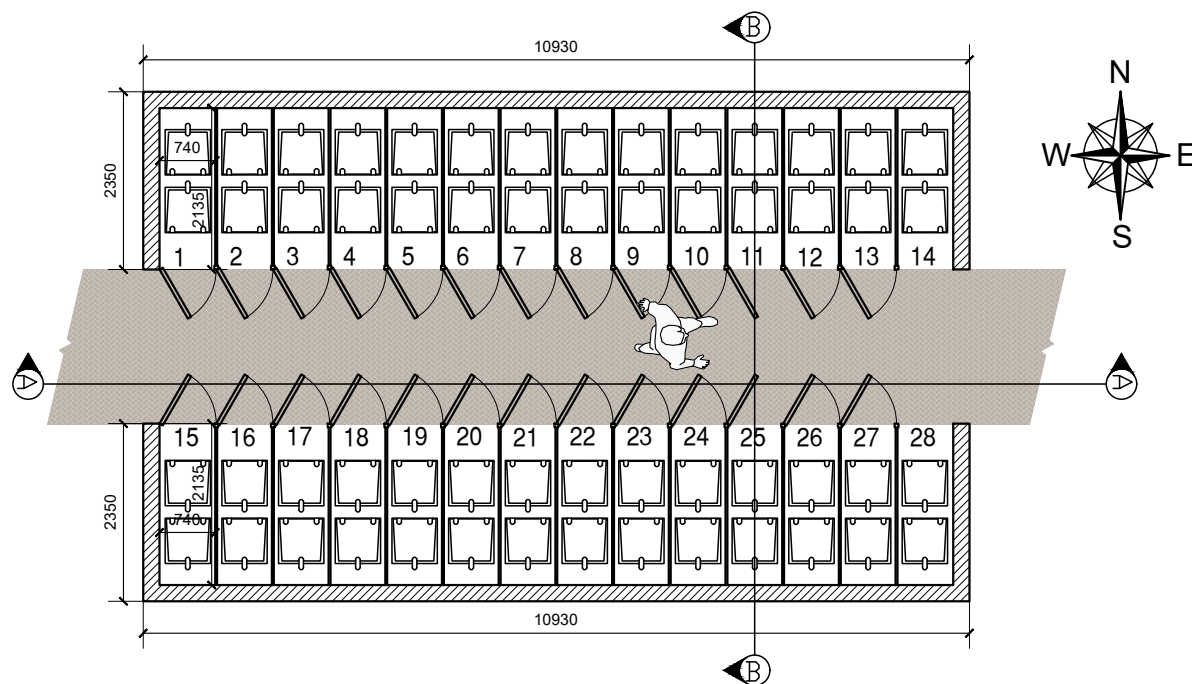

TYPICAL BIN STORE PLAN

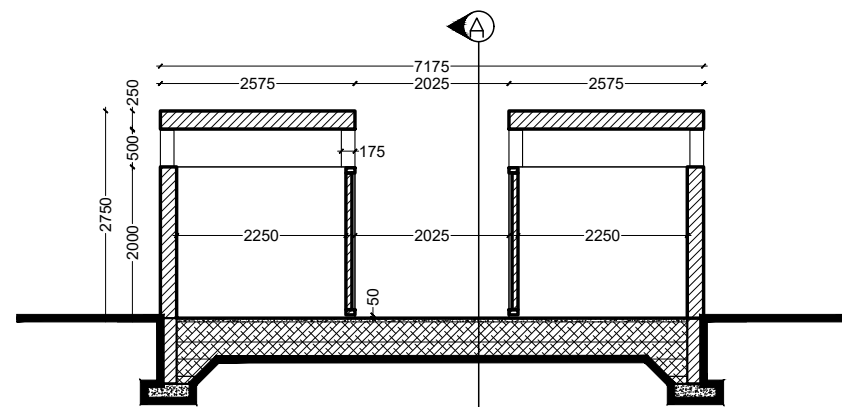

SECTION B-B

- NOTES:
1. FOR INDIVIDUAL UNIT FLOOR LEVELS PLEASE REFER TO ENGINEERING SITE LAYOUT
  2. FOR INDIVIDUAL UNIT NORTH POINT ORIENTATION PLEASE REFER TO SITE LAYOUT MAP
  3. APPLIED BRICK FINISH IS DEPENDENT ON AVAILABILITY AND SITE LOCATION
  4. ALL DIMENSIONS ARE IN mm
  5. PLANNING DRAWING ONLY
  6. DO NOT SCALE FROM DRAWINGS

REV. DATE	DRN	NOTES

**PLANNING**

**Gittens Murray Architects Ltd.**

JOB  
 WATERROCK HOUSING  
 MIDLETON, CO. GORK

CLIENT  
 HAVEN FALLS LTD.

TITLE  
 TYPICAL BIN STORAGE

DATE 07.10.2022 SCALE 1:100@A3  
 DRN CHECKED MG

JOB NUMBER 20/033-LRD-H-A-901  
 DRWG NUMBER  
 REVISION

TEL: (0 56) 77 53933  
 FAX: (0 56) 77 53909  
 email: info@gmarch.net

DETAIL NUMBER  
 LOCATION SHEET  
 DETAIL NAME  
 DETAIL SCALE

**GMA**  
 ARCHITECTS  
 INTERIOR DESIGNERS  
 2 Patricks Court,  
 Patricks St.  
 Kilkenny.